

Torneira Eletrônica Parede

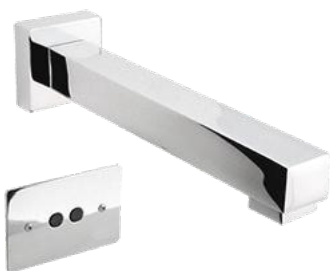

Modelo K ÚBICA



Torneira de parede com sensor Infravermelho: acionamento automático pela presença do usuário sem contato manual

Informações Técnicas:

Versão	Alimentação	Consumo	Operação	Vazão	Conexão	Despacho
Elétrica	110/220Vca	0,5W rep. 8W acion	NBR 5626	0,07L/seg (4L/min)	1/2"	2,2Kg
Misturador		0,5W rep. 16W acio	NBR 9050	Registros p/ ajuste		2,9Kg

Instalação

Versão	Código
Elétrica	90.570
Misturador	90.571

Dimensional

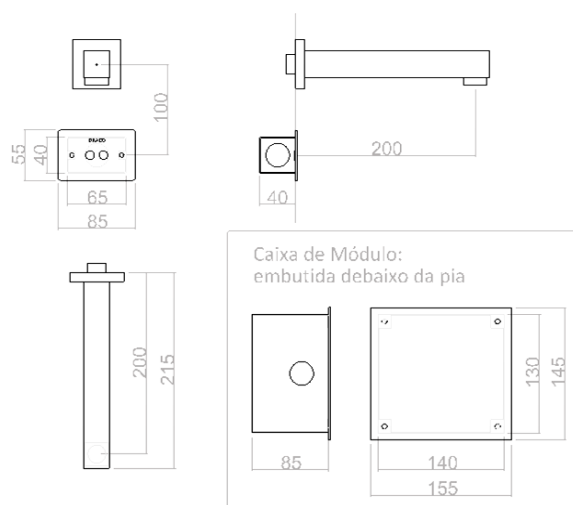

Opcional

Item	Informações
Dispositivo Economizador 80.080	Vazão 0,03L/Seg (1,8L/min)

Bica Kúbica Hidráulica e Elétrica

acabado

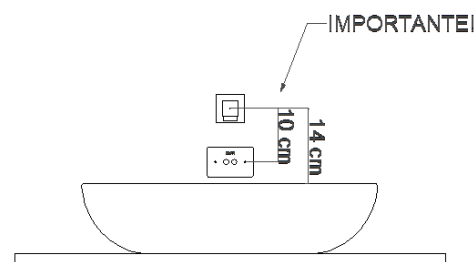
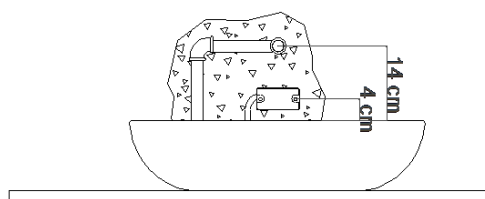
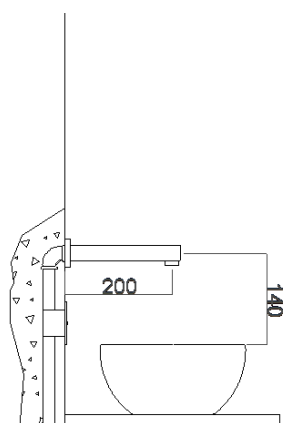

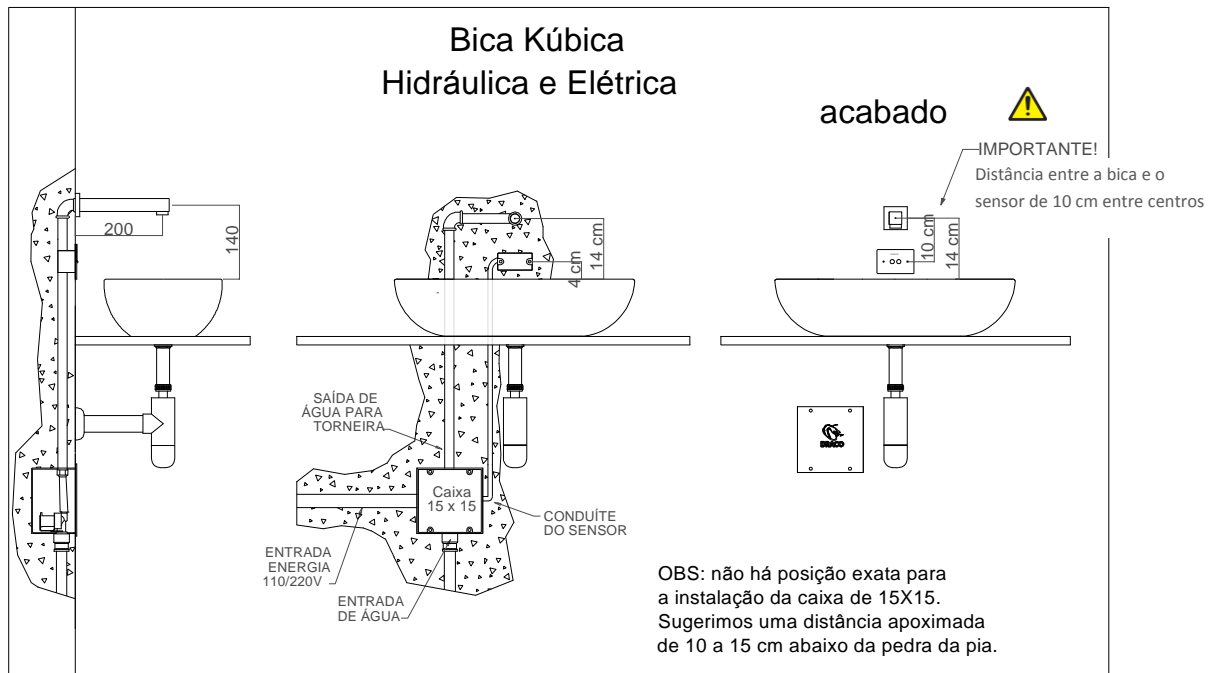

Padrão Embutida

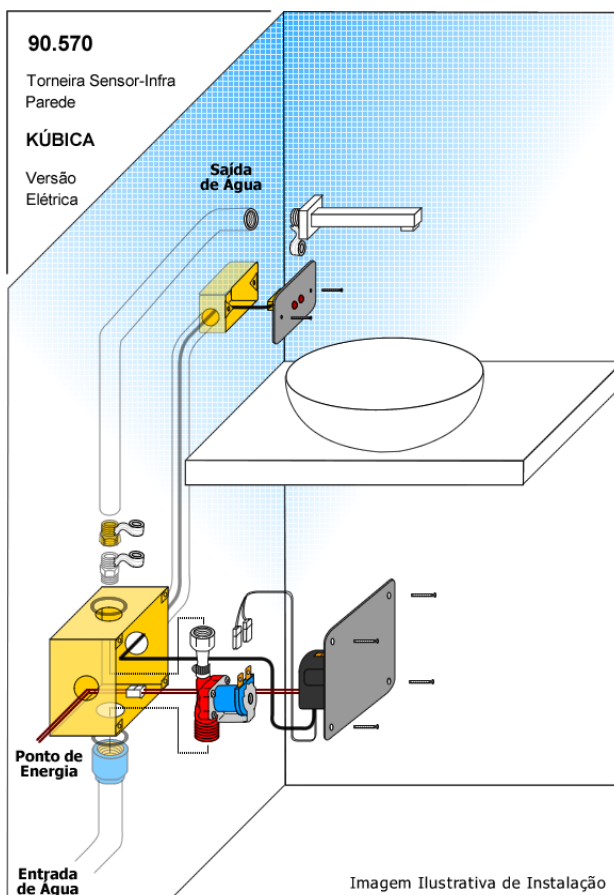

MIX (misturador)

